

Inquiry and order form for rotary table type RT (1)

Firm _____ E-Mail Address _____
 Contact person _____ Project no. / Order no. _____
 Tel. / Fax _____ Date _____

Index plate Diameter [mm] _____
 Depth [mm] _____
 Material or weight _____

Fixtures and workpieces Quantity _____
 Mass/Station [kg] _____
 Reference diameter [mm] _____

Stop mode (fixed step time, variable dwell time)
 Continuous mode (fixed step and dwell time)
 Required step time [s] _____
 Required dwell time [s] (continuous mode only) _____
 Number of cycles [1/min] _____
 Required service life (actual cycle time, normal 12,000 h) _____

Additional forces and loads (please give details)

Please visit our website at www.taktomat.de where you can download a program for calculating the rotary table data!

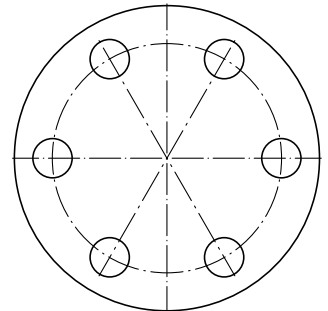
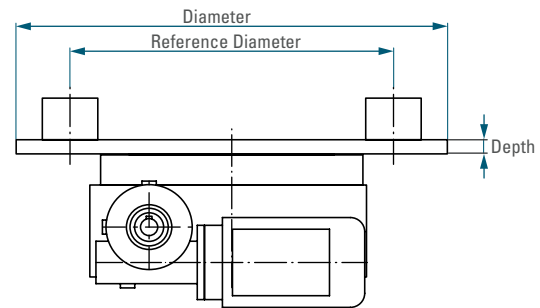

Possible mounting positions for the drive units

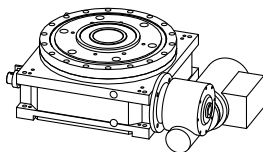

1SL90

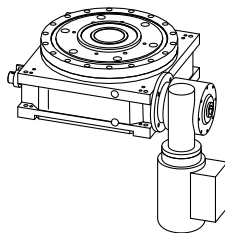

1SL180

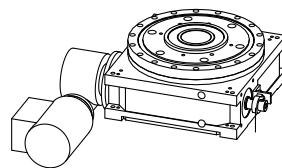

2SL90

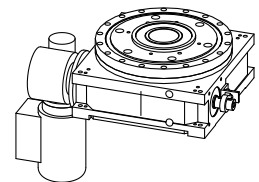

2SL180

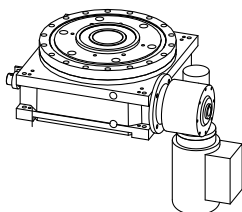

1SR180

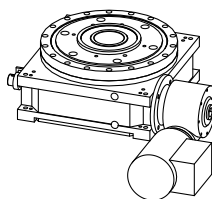

1SR270

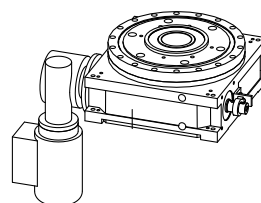

2SR180

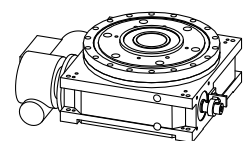

2SR270

Inquiry and order form for rotary table type RT (2)

Index Table

Type RT (100-630) _____

Number of stops _____

Index angle other than standard (see load table) _____

Mounting position (underneath) no. _____

Direction of rotation of output flange

Clockwise Counterclockwise Reverse

Cam lead Right (standard) Left

Standard central column Yes No

If No Extended by _____ mm

Standard hole pattern

Hole pattern as specified on drawing _____

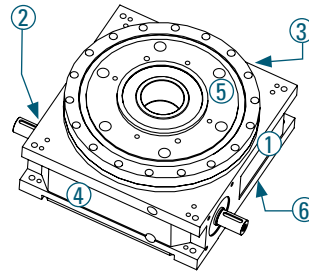

possible mounting positions

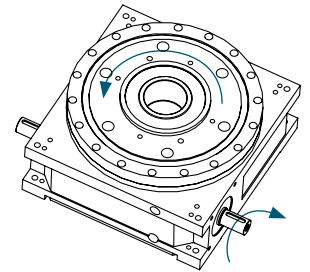

Cam Lead Right (Standard)

Drive

With drive

Drive position (see page 1) _____

Terminal box position (see below) _____

Motor voltage 230/400-50 Hz

Other voltage _____

Brake voltage 24V DC

Other voltage _____

Manual release on brake Yes No

Motor Handwheel Yes No

Input Safety Clutch Yes No

Additional specifications (temperature sensor, connector assembly, brand...)

Without drive

Direction of rotation of input shaft _____

Input shaft Ø _____ ; Length _____

Universal Controller TIC

Universal Controller TIC Yes No

Color

Cast housing RAL7016 other _____

Drive color of manufacturer other _____

Terminal box position

